

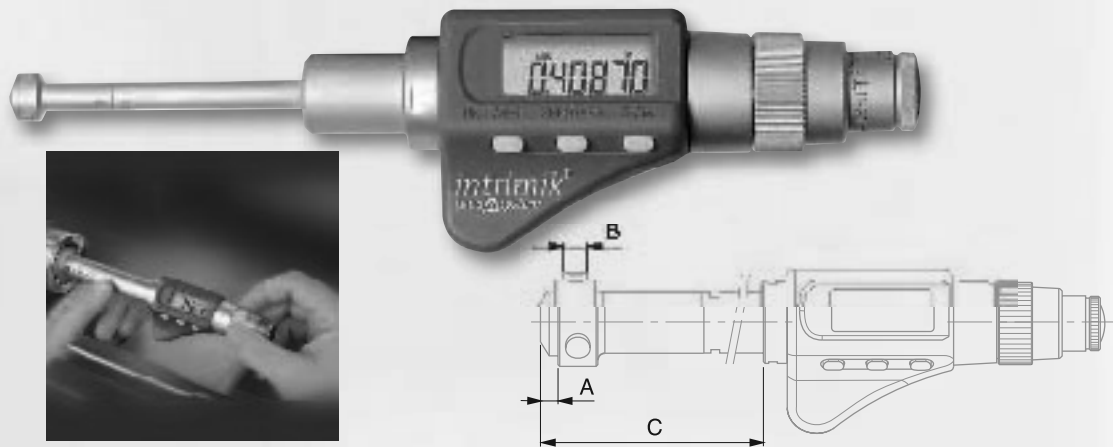



























Micromaster INTRIMIK® with "capa μ system"® and Digital Display

 *New capacitive measuring system (patented) associated with the unique cone of the Brown & Sharpe INTRIMIK internal micrometers.*



-  ✓
-  DIN 863 T4 (style C1)
-  0.00005" / 0.001 mm
-  mm / in conversion
-  LCD, .275" / 7 mm digit height
-  Floating zero
-  Display lock
-  Measuring faces for application ranges .138" to .472" / 3.5 to 12mm: hardened steel (770 HV) .433 in to 3.94 in / 11 to 100mm: TIN hard-coating, hardness to 0.05 2300 HV. 3.95"-11.80"/100 to 300 mm: carbide tipped (1300 HV)

-  Opto-coupled RS-232 interface, bidirectional.
-  3 V lithium battery
-  1 to 2 a (2000 h/a)
-  Automatic shut down after 10 min. Display setting is retained as long as power supply remains stable.
-  50 °F to 104 °F / 10 °C to 40 °C
-  14 °F to 140 °F / -10 °C to 60 °C
-  80 %, with no condensation
-  ✓
-  Protection of the meas. element IP 54 (IEC 60529) or IP 40 with use of digital output
-  Plastic case
-  Identification number
-  In-house calibration certificate
-  Declaration of conformity

		 in	 mm	 in	 μm	 Ain/mm	Bin/mm	Cin/mm
599-290-28-1	27499	.138 - .158	3.5 - 4	.00016	4	.079 / 2	.059 / 1.5	.787 / 20
599-290-30-1	27500	.158 - .178	4 - 4.5	.00016	4	.079 / 2	.059 / 1.5	.787 / 20
599-290-32-1	27501	.178 - .217	4.5 - 5.5	.00016	4	.079 / 2	.059 / 1.5	.984 / 25
599-290-34-1	27502	.217 - .256	5.5 - 6.5	.00016	4	.079 / 2	.059 / 1.5	.984 / 25
599-290-35-1	27503	.240 - .320	6 - 8	.00016	4	.098 / 2.5	.059 / 2.5	2.17 / 55
599-290-42-1	27504	.320 - .400	8 - 10	.00016	4	.098 / 2.5	.059 / 2.5	2.17 / 55
599-290-50-1	27505	.400 - .480	10 - 12	.00016	4	.098 / 2.5	.059 / 2.5	2.17 / 55
599-290-60-1	27506	.430 - .550	11 - 14	.00016	4	.139 / 3.5	.158 / 4	2.68 / 68
599-290-70-1	27507	.550 - .670	14 - 17	.00016	4	.139 / 3.5	.158 / 4	2.68 / 68
599-290-80-1	27508	.670 - .790	17 - 20	.00016	4	.139 / 3.5	.158 / 4	3.27 / 83
599-290-100-1	27509	.790 - .990	20 - 25	.00016	4	.277 / 7	.158 / 7	3.27 / 83
599-290-120-1	27510	.990 - 1.18	25 - 30	.00016	4	.277 / 7	.158 / 7	3.5 / 88
599-290-140-1	27511	1.18 - 1.38	30 - 35	.00016	4	.277 / 7	.158 / 7	3.5 / 88
599-290-160-1	27512	1.38 - 1.58	35 - 40	.00016	4	.277 / 7	.158 / 7	3.5 / 88
599-290-200-1	27513	1.58 - 1.98	40 - 50	.00024	5	.433 / 11	.472 / 12	3.85 / 98
599-290-240-1	27514	1.98 - 2.38	50 - 60	.00024	5	.433 / 11	.472 / 12	3.85 / 98
599-290-280-1	27515	2.36 - 2.76	60 - 70	.00024	5	.433 / 11	.472 / 12	3.85 / 98
599-290-320-1	27516	2.76 - 3.16	70 - 80	.00024	5	.433 / 11	.472 / 12	3.85 / 98
599-290-360-1	27517	3.15 - 3.55	80 - 90	.00024	5	.433 / 11	.472 / 12	3.85 / 98
599-290-400-1	27518	3.55 - 3.95	90 - 100	.00024	5	.433 / 11	.472 / 12	3.85 / 98
599-290-420-1	27519	3.95 - 4.94	100 - 125	.00024	6	1.02 / 26	.71 / 18	3.93 / 100
599-290-440-1	27520	4.94 - 5.90	125 - 150	.00024	6	1.02 / 26	.71 / 18	3.93 / 100
599-290-460-1	27521	5.90 - 6.90	150 - 175	.00028	7	1.02 / 26	.71 / 18	3.93 / 100
599-290-480-1	27522	6.90 - 7.88	175 - 200	.00028	7	1.02 / 26	.71 / 18	3.93 / 100
599-290-500-1	27523	7.88 - 8.86	200 - 225	.00032	8	1.02 / 26	.71 / 18	3.93 / 100
599-290-520-1	27524	8.86 - 9.85	225 - 250	.00032	8	1.02 / 26	.71 / 18	3.93 / 100
599-290-540-1	27525	9.85 - 10.84	250 - 275	.00032	8	1.02 / 26	.71 / 18	3.93 / 100
599-290-560-1	27526	10.84 - 11.80	275 - 300	.00032	8	1.02 / 26	.71 / 18	3.93 / 100
Battery								
19.61000	86485	1 lithium battery - 3V, 190 mAh, type CR 2032						
Cable								
47.61046	61046	RS-232 optional coupled cable, 6.5 ft. / 2 in (9-pin)						