

INSPECTION ARSENAL™ is a ready-made fixture system for CMM inspections. Create affordable, repeatable, and durable fixtures that reduce setup time for faster inspection with Loc-N-Load™ plates and non-marring clamps. Aluminum plates interlock magnetically to remain firmly secured yet release quickly and easily for the next job. The system easily installs on all CMMs. An order placed today can be improving productivity and profits tomorrow.

Select the size Docking Rail and Plate Bundle —12", 18" or 30"— that suits your application.

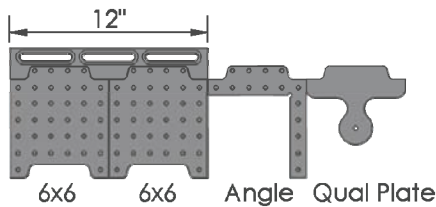

12" Rail Bundle System	
+ Starter Kit	\$1499
+ Complete Kit	\$1599
+ WORKS Kit	\$3129

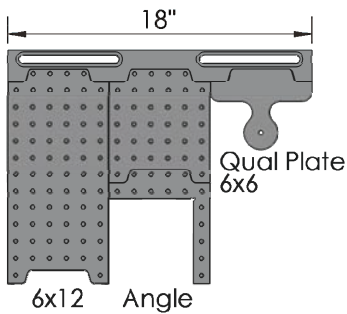

18" Rail Bundle System	
+ Starter Kit	\$1589
+ Complete Kit	\$1689
+ WORKS Kit	\$3219

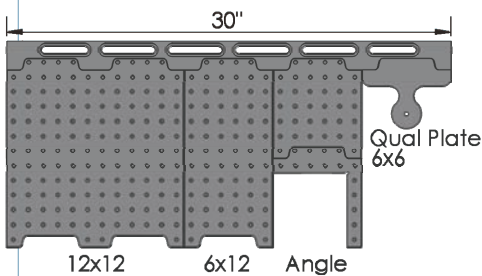

30" Rail Bundle System	
+ Starter Kit	\$2029
+ Complete Kit	\$2129
+ WORKS Kit	\$3659

Choose a work holding kit for your Bundled System: —Starter, Complete, or The WORKS.
Combine with additional plates and clamps as needed.

STARTER Kit (50 pcs)

See Pg. 6 for all Kit contents



COMPLETE Kit (69 pcs)

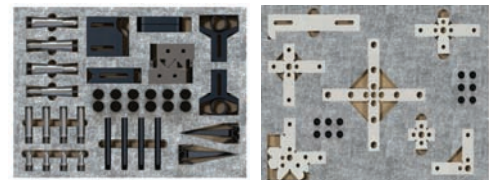

The WORKS Kit (145 pcs)

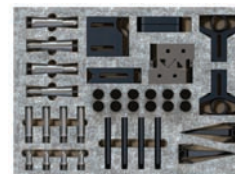

Plates sold separately

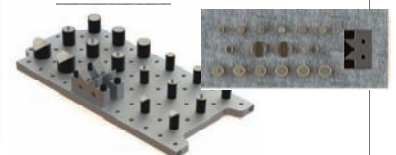
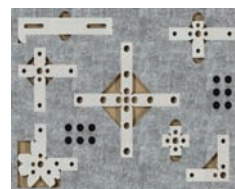

Part #	SELECT DOCKING RAIL & PLATE BUNDLE									CHOOSE A KIT		
	Bundle Description (Rail Size / Kit)	Price	Rail Size	Rail Qty	6 x 6 Plate	6 x 12 Plate	12 x 12 Plate	Angle Plate	Qual Plate	Starter TR-03	Complete TR-02	WORKS TR-01
SYS05: DK12TR03	12" Dock + Starter Kit	\$1499	12 x 2	1	2			1	1	1		
SYS05: DK12TR02	12" Dock + Complete Kit	\$1599	12 x 2	1	2			1	1		1	
SYS05: DK12TR01	12" Dock + WORKS Kit	\$3129	12 x 2	1	2			1	1			1
SYS10: DK18TR03	18" Dock + Starter Kit	\$1589	18 x 2	1	1	1		1	1	1		
SYS10: DK18TR02	18" Dock + Complete Kit	\$1689	18 x 2	1	1	1		1	1		1	
SYS10: DK18TR01	18" Dock + WORKS Kit	\$3219	18 x 2	1	1	1		1	1			1
SYS20: DK30TR03	30" Dock + Starter Kit	\$2029	30 x 2	1	1	1	1	1	1	1		
SYS20: DK30TR02	30" Dock + Complete Kit	\$2129	30 x 2	1	1	1	1	1	1		1	
SYS20: DK30TR01	30" Dock + WORKS Kit	\$3659	30 x 2	1	1	1	1	1	1			1