

32-1170 REV 2



^ Female square drive



^ Male square drive



< Unique Plug & Test™ technology allows for interchangeable sensors to be used with a Mark-10 indicator. All calibration and configuration data is saved in the smart connector.



< The Plug & Test™ connector locks into the receptacle in the indicator when fully inserted. Dual buttons on the indicator housing release the connector for easy removal. Gold plated spring contacts ensure long lasting and reliable connection.

This rugged series of torque sensors is ideal for a wide range of torque testing applications in numerous industries. Square drives on both ends permit inline use with a torque wrench, or for use in OEM and other applications. Capacities available from 20 to 5,000 lbFin (2 to 550 Nm). Compatible with Mark-10 indicators (sold separately) through unique Plug & Test™ technology.

Dimensions in [mm]

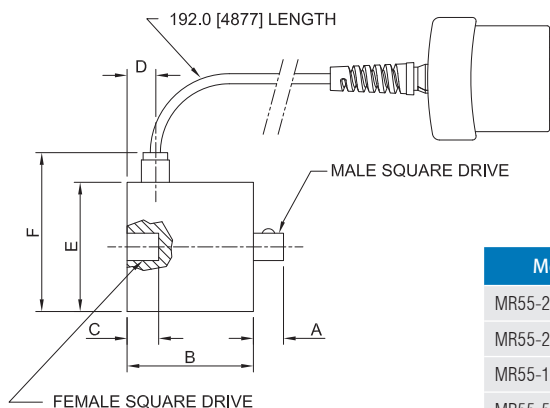

Specifications

Accuracy:	±0.6% of full scale + indicator
Safe Overload:	150% of full scale
Weight:	MR55-20 - MR55-1000: 1.3 lb [0.6 kg] MR55-5000: 1.9 lb [0.9 kg]

Model No.	Drive Size	A	B	C	D	ØE	F
MR55-20 - MR55-100	1/4"	0.30 [0.75]	1.73 [44.0]	0.32 [8.0]	0.39 [10.0]	1.77 [45.0]	2.32 [59.0]
MR55-200 - MR55-400	3/8"	0.41 [10.5]	1.73 [44.0]	0.43 [11.0]			
MR55-1000	1/2"	0.59 [15.0]		0.63 [16.0]			
MR55-5000	3/4"	0.89 [22.5]	2.11 [53.5]	0.94 [24.0]	0.77 [19.5]	2.01 [51.0]	2.56 [65.0]

Capacity x Resolution

Model No.	With Models 7i & 5i indicators						With Model 3i indicator			
	lbFin	ozFin	lbFft	kgFmm	Ncm	Nm	lbFin	ozFin	kgFmm	Ncm
MR55-20	20 x 0.02	320 x 0.2	1.5 x 0.002	-	220 x 0.2	2 x 0.002	20 x 0.02	320 x 0.5	-	220 x 0.2
MR55-50	50 x 0.05	800 x 0.5	4 x 0.005	-	570 x 0.5	5.7 x 0.005	50 x 0.05	800 x 1	-	570 x 0.5
MR55-100	100 x 0.1	1600 x 1	8 x 0.01	-	1150 x 1	11.5 x 0.01	100 x 0.1	1600 x 2	-	1150 x 1
MR55-200	200 x 0.2	-	16 x 0.02	2300 x 2	2200 x 2	22 x 0.02	200 x 0.2	-	2300 x 2	2200 x 2
MR55-400	400 x 0.5	-	32 x 0.05	4600 x 5	4500 x 5	45 x 0.05	400 x 0.5	-	4600 x 5	4500 x 5
MR55-1000	1000 x 1	-	80 x 0.1	11500 x 10	11000 x 10	110 x 0.1	1000 x 1	-	11500 x 10	11000 x 10
MR55-5000	5000 x 5	-	400 x 0.5	55 x 0.05 kgFm	55000 x 50	550 x 0.5	5000 x 5	-	55 x 0.05 kgFm	550 x 0.5 Nm



Mark-10 Corporation ■ www.mark-10.com ■ info@mark-10.com
Toll-free: 888-MARK-TEN ■ Tel: 631-842-9200 ■ Fax: 631-842-9201



Specifications subject to change without prior notice